



bringing the world to you since **1971**

Assembly Instructions

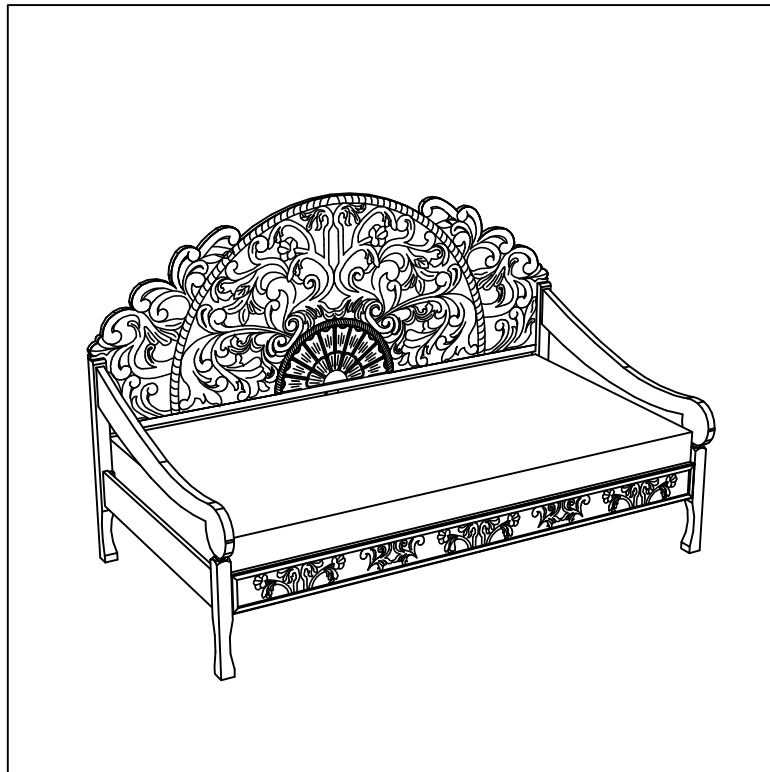

Zarah Carved Daybed

SKU 9353495469816





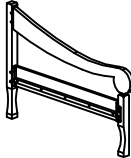
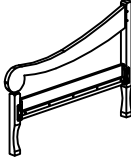
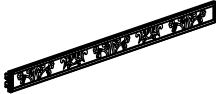
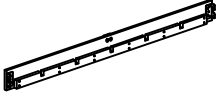
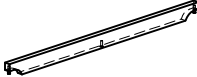

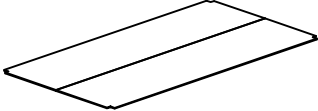
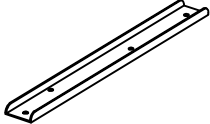
THANK YOU FOR PURCHASING THIS BEAUTIFULLY HAND CRAFTED
PIECE OF FURNITURE. ENCLOSED ARE THE ASSEMBLY INSTRUCTIONS.
IF YOU HAVE ANY FURTHER QUERIES ON HOW TO CONSTRUCT YOUR
ITEM, PLEASE

Component List

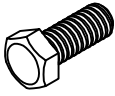
LABEL	PICTURE	DESCRIPTION	QTY
A		Headboard	1
B		Right Arm	1
C		Left Arm	1
D		Front Rail	1
E		Back Rail	1
F		Center Slat	1
G		End Slat	4
H		Support Leg	5
I		Mattress Panel	1
J		Metal Support	1

Hardware List

LABEL	PICTURE	DESCRIPTION	QTY
H-1		Hex Bolt M8 x 20mm	8
H-2		Spring Washer Ø13 x M8	19
H-3		Flat Washer Ø17 x M8	8
H-4		Bolt M6 x 20mm	11

Tool List

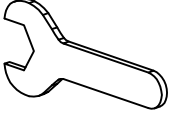
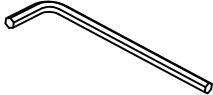
LABEL	PICTURE	DESCRIPTION	QTY
T-1		Wrench	1
T-2		Allen key	1

Assembly Preparation

Before Beginning :

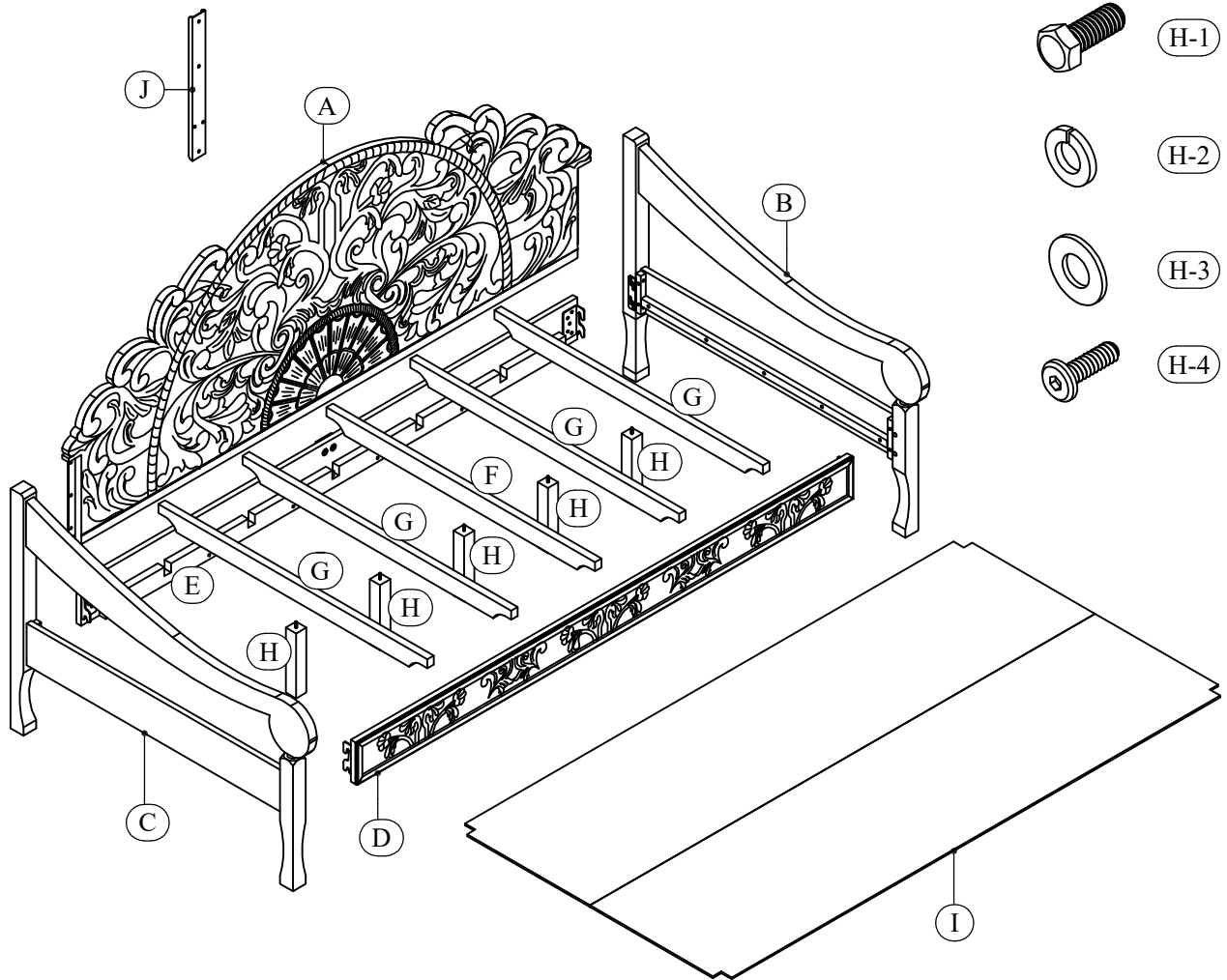

- Unpack all hardware, bags and components to ensure you have all parts before assembly



- Read instructions, cover to cover before assembly



- Have 2 adults on hand for assembly



- Do not assemble on flooring or carpet





- Assemble on a clean non-marring surface (eg: packing foam)



- Save all packaging until assembly is finished and you are content with your purchase

Assembly Steps

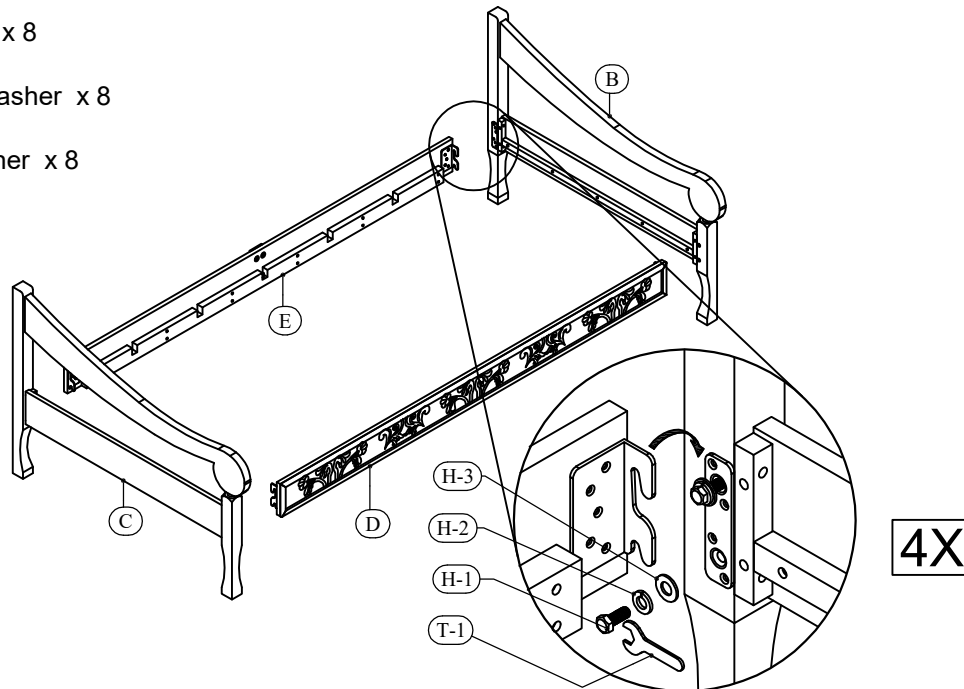

STEP 1 : Assembling Rails and Arms

-  (H-1) Hex Bolt x 8
-  (H-2) Spring Washer x 8
-  (H-3) Flat Washer x 8



Attach Front Rail (D) and Back Rail (E) to Right Arm (B) Secure with Hex Bolt (H-1), Spring Washers (H-2) and Flat Washers (H-3) Tighten using Wrench (T-1). Repeat for Left Arm (C). The bolts, washers to be loosely attached to allow centering and adjustment before tightening down

STEP 2 : Assembling Headboard

-  (H-2) Spring Washer x 11
-  (H-4) Bolt x 11

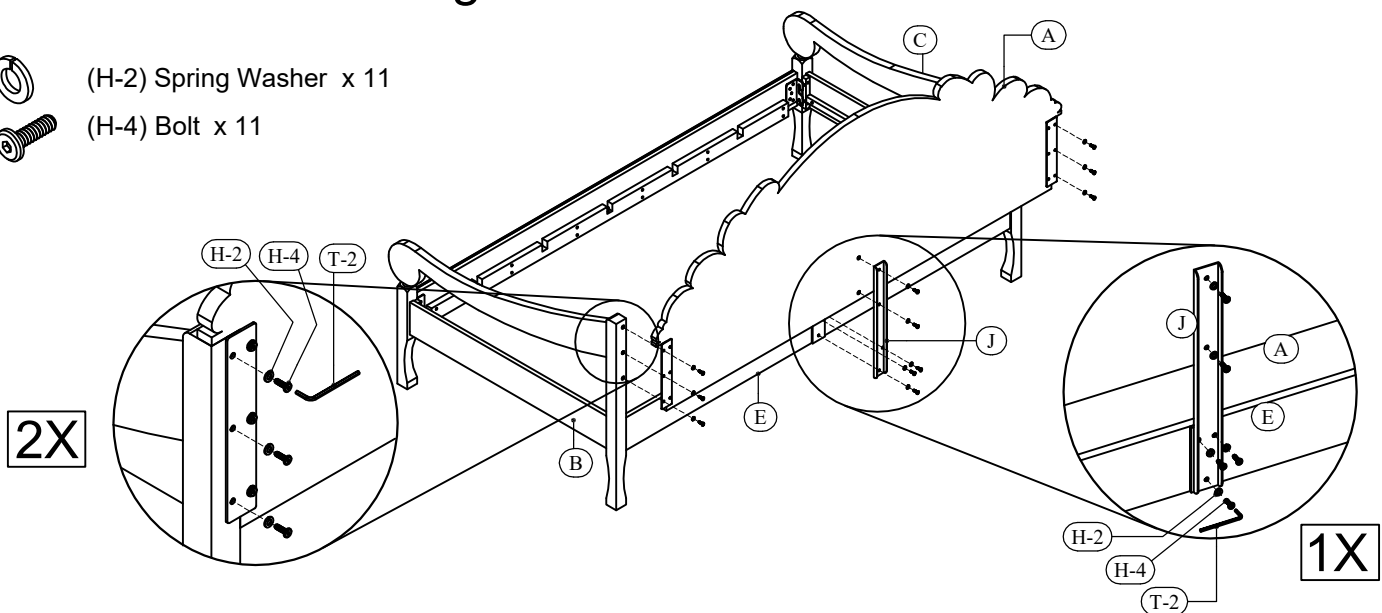

Attach Headboard (A) to Right Arm (B) and Left Arm (C) Secure with Bolt (H-4) and Spring Washers (H-2) Tighten using Allen Key (T-2). Attach Metal Support (J) using bolt (H-4) and Spring Washer (H-2) as shown above.

Assembly Steps

STEP 3 : Assembling Slats and Support Legs

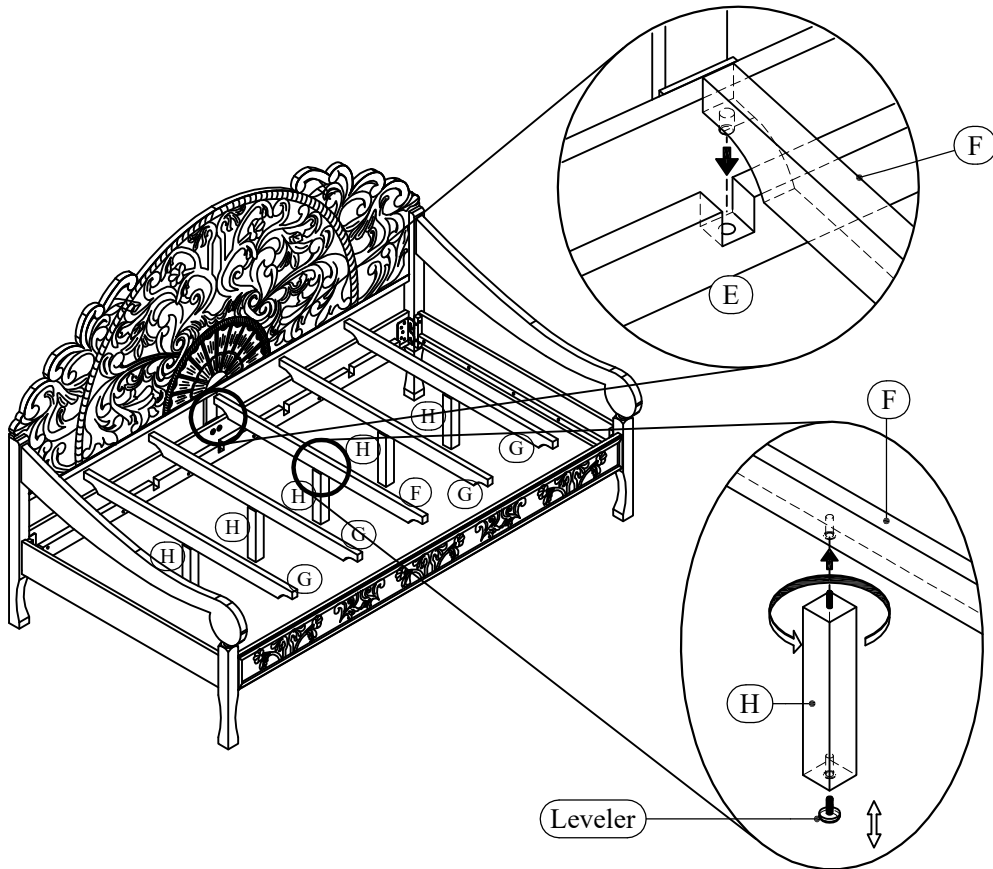

Attach center support leg as shown above turn leg clockwise until tight. Leveler is available if needed to help support and stabilize the daybed. only Center Slat (F) have wooden dowel.

STEP 4 : Assembling Mattress Panel

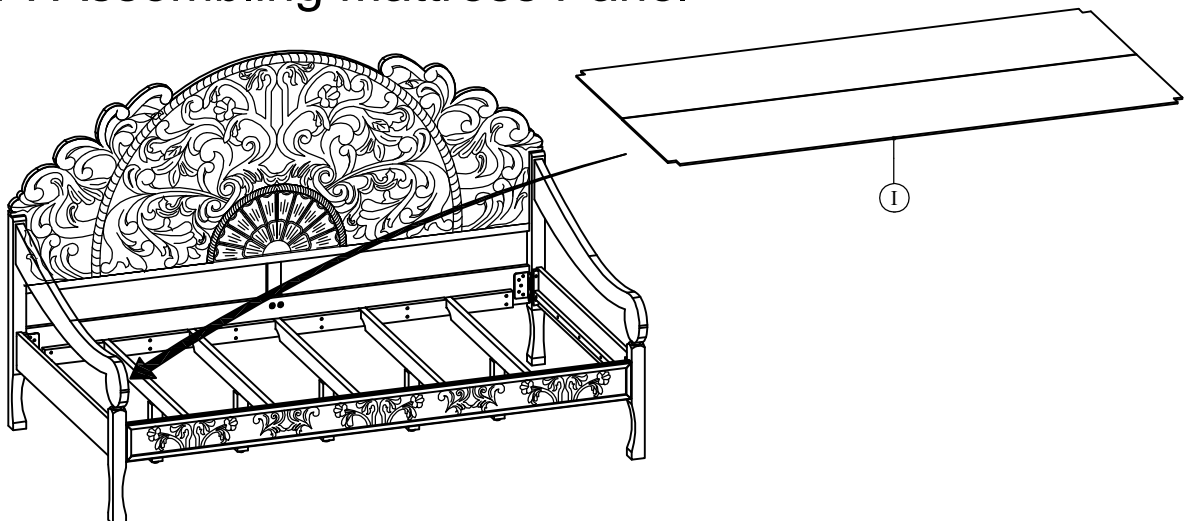

Place the mattress panel as shown above. The Daybed is now ready to use.

Care & Maintenance



- Do not put hot items directly on furniture surface.



- Do not write on furniture without a padded barrier to protect the surface.



- Do not clean furniture with harsh cleansers or polish.



- Do not place furniture outside. For indoor use only.



- Do not place furniture in direct sunlight.



- Not for commercial use. For residential use only.



- Do not place furniture near heating or cooling vents.



- Dust and pick-up spills using a clean, non-colored, lint-free cloth.



- Stains may be removed with mild soap solution and damp cloth.